

SSI Technologies – Application Note PS-AN9

MediaSensor™ P51 Series LA

Low Pressure Absolute Pressure Sensors

Product Description

SSI Technologies Inc., offers the **MediaSensor™ Series LA absolute pressure sensors** targeted at industrial and commercial applications where low pressure, cost, compact size, robust packaging, chemical compatibility and performance are critical.

These MediaSensor™ P51 Series LA bulk micro-machined, absolute pressure sensors are designed to work at low pressure ranges (**15 psi to 200 psi**) with superior *accuracy*.

The MediaSensor™ P51 Series LA pressure sensor are cost competitive, compact, have robust packaging with a wide variety of fittings that work in both harsh and benign media. They are ideal for a variety of pressure measurement applications in the automotive, industrial and commercial industries. Four different electrical signal outputs are available for use by computers, digital panel meters, PLCs, chart recorders and other devices that can display, record or change the pressure in a closed loop system.

Product Features

- **Pressure Ranges:**
 - 15 psia (103 kPa),
 - 50 psia (345 kPa)
 - 75 psia (517 kPa)
 - 100 psia (689 kPa)
 - 200 psia (1380 kPa)
- **Superb Accuracy:**
 - $\pm 0.5\%$ overall full scale at room temperature
 - $\pm 1\%$ overall full scale over -40°C to 105°C for 75 PSI to 200 PSI.
 - includes Repeatability, Hysteresis and Linearity
- **Maximum Flexibility:** Custom ASIC provides signal conditioning for calibration and temperature compensation



MediaSensor™ Low Pressure Sensors with integrated signal conditioning (shown with various ports and connectors)

- **Compact, Robust Package:** All laser-welded stainless steel design for optimal media isolation
- **Electrical Connectors:** Packard, Deutsch, MD-DIN, M12, Integral Harness
- **Electronics:**
 - 0.5 – 4.5 Volt output (with 5V input)
 - 0.5 – 4.5 Volt output with overvoltage protection (with 5V input)
 - 1 – 5 Volt Output (with 8 – 30V input)
 - 4-20 mA (with 8 – 30V input)
- **Standard and Custom Options**

Call us at **(888) 477-4320**
or visit our

Web Site: <http://ssitechnologies.com>



SSI Technologies – Application Note PS-AN9

MediaSensor™ P51 Series LA

Low Pressure Absolute Pressure Sensors

Chemical Compatibilities: Any gas or liquid compatible with 304L & 316L stainless steel.

- Refrigerant
- Motor Oil
- Diesel
- Hydraulic Fluid
- Brake Fluid
- Water
- Waste Water
- Hydrogen
- Nitrogen
- Air

Typical Applications

- Refrigeration
- Fuel Cells
- Pumps
- Hydraulics
- Compressors
- Robotics
- Pneumatics
- Agriculture
- Spraying Systems
- Process Control
- Flow
- Hydrogen Storage

Typical Connections

The following torque limits should be used when mounting the MediaSensor™ pressure port.

Straight Thread w/O-Ring:	Recommended Torque
All others with out Port types T, U, Y	150 in lb
Parts with Ports T,U, Y	120 in lb

MediaSensor™ Transmitter (4 -20mA) connections:

- 1) Connect the Power Lead (Red) to the + terminal of the supply voltage.
- 2) Connect the Return Lead (White) to the + terminal of the current measuring device
- 3) Connect the – terminal of the current measuring device to the – terminal of the supply voltage

MediaSensor™ Transducer (Voltage Output) connections:

- 1) Connect the Power Lead (Red) to the + terminal of the supply voltage.
- 2) Connect the Ground Lead (Black) and the – terminal of the supply voltage to – input of your voltage measurement equipment.
- 3) Connect the Vout Lead (White) to the + input of your voltage measurement equipment.



SSI Technologies – Application Note PS-AN9

MediaSensor™ P51 Series LA

Low Pressure Absolute Pressure Sensors

Packaging

MediaSensor™ is readily available in a large selection of standard packaging options. MediaSensor™ offers an integral harness with 6 standard lengths and four standard readily available connectors (Packard, Deutsch, M12 and Mini DIN). In addition, SSI will work with the customer to meet their needs with custom options for large volumes orders. (I.e... special fittings & connectors; special pressure ranges; operating temperature; and increased accuracy).

Integral Harness (Standard lengths of 6", 12", 18", 24", 36" and 72"). The Harness can be constructed of either PVC Jacketed 18 or 24 AWG Wire.

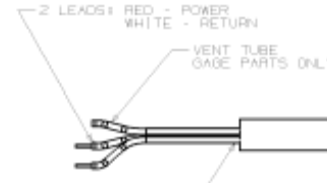

Wire Color
Red - Power
White - Return

Integral Harness Transmitter (4 to 20 mA)

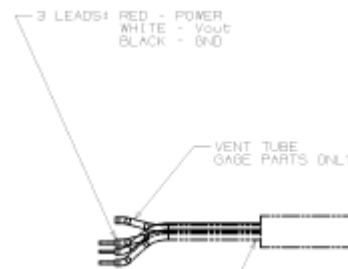

Wire Color
Red - Power
White - Vout
Black - Ground

Integral Harness Transducer(1 to 5 Vdc or 0.5 to 4.5Vdc)



SSI Technologies – Application Note PS-AN9

MediaSensor™ P51 Series LA

Low Pressure Absolute Pressure Sensors

Standard Connector Options

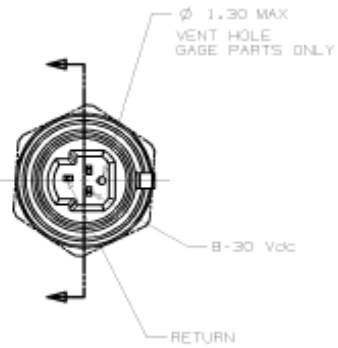

- Pin 1 - Power
- 2 - Not Used
- 3 - Return

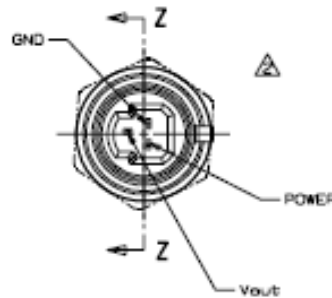

- Pin 1 - Power
- 2 - Ground
- 3 - Vout

Packard Connector Transmitter (4 to 20 mA)

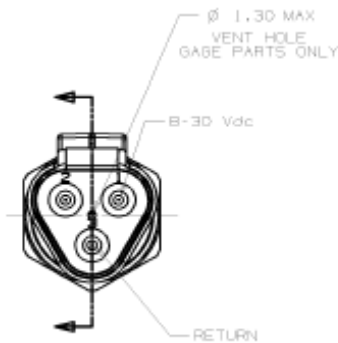

- Pin 1 - Power
- 2 - Not Used
- 3 - Return

Deutsch Connector Transmitter (4 to 20 mA)

Packard Connector Transducer (1 to 5 Vdc or 0.5 to 4.5Vdc)

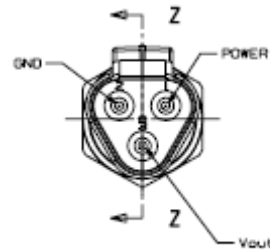

- Pin 1 - Power
- 2 - Ground
- 3 - Vout

Deutsch Connector Transducer (1 to 5 Vdc or 0.5 to 4.5Vdc)



SSI Technologies – Application Note PS-AN9

MediaSensor™ P51 Series LA

Low Pressure Absolute Pressure Sensors

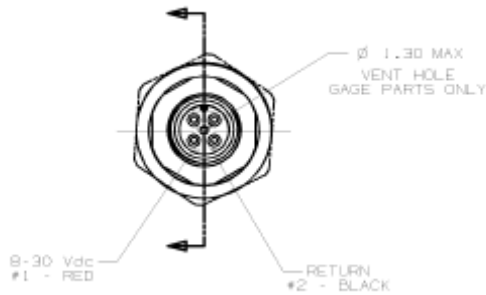

- Pin 1 - Power
- 2 - Return
- 3 - Not Used
- 4 - Not Used

M12 Connector Transmitter (4 to 20 mA)

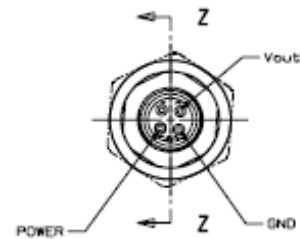

- Pin 1 - Power
- 2 - Ground
- 3 - Vout
- 4 - Not Used

M12 Connector Transducer (1 to 5 Vdc or 0.5 to 4.5Vdc)

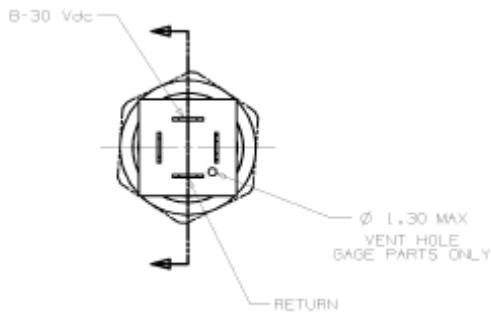

- Pin 1 - Power
- 2 - Return
- 3 - Not Used
- 4 - Not Used

DIN 43650 Transmitter Connector

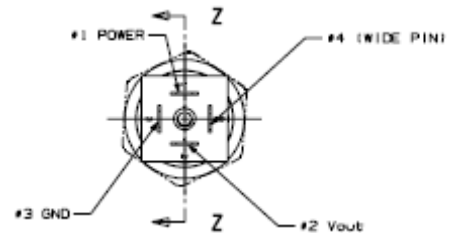

- Pin 1 - Power
- 2 - Vout
- 3 - Ground
- 4 - Not Used

DIN 43650 Transducer Connector



SSI Technologies – Application Note PS-AN9

MediaSensor™ P51 Series LA

Low Pressure Absolute Pressure Sensors

Standard Packaging Options

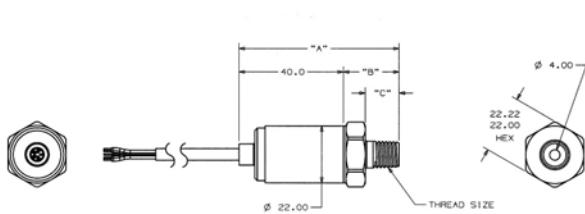

THREAD SIZE	LENGTH "A"	LENGTH "B"	LENGTH "C"
1/4-18 NPT	66.6	26	18
1/8-27NPT	61.6	21	13
7/16-20UNF	59.6	19	11
9/19-18 UNF	59.6	19	11
3/8-24 UNF	58.1	17.5	9.5

Integral Harness with 22mm Hex

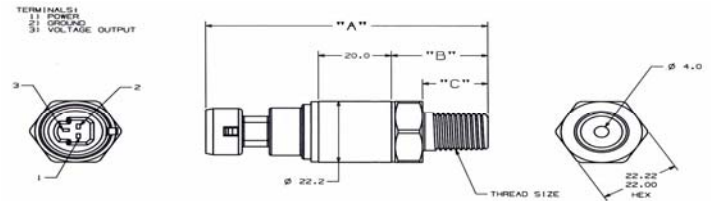

THREAD SIZE	LENGTH "A"	LENGTH "B"	LENGTH "C"
1/4-18 NPT	70.0	26.0	18.0
1/8-27NPT	65.0	21.0	13.0
7/16-20UNF	63.0	19.0	11.0
9/19-18 UNF	63.0	19.0	11.0
3/8-24 UNF	61.5	17.5	9.5

Packard Connector with 22mm Hex 5 Vdc Input: 0.5 – 4.5 Vdc Ratiometric Output

Harness Construction: PVC Jacketed 24 AWG Wire

Mating Packard Connector P/N 12065287 and Mating Packard Terminal P/N 12103881

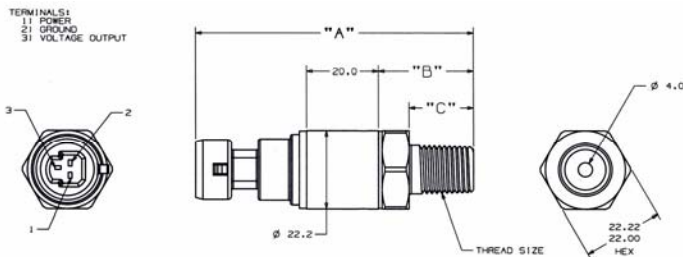

THREAD SIZE	LENGTH "A"	LENGTH "B"	LENGTH "C"
1/4-18 NPT	70.0	26.0	18.0
1/8-27NPT	65.0	21.0	13.0
7/16-20UNF	63.0	19.0	11.0
9/19-18 UNF	63.0	19.0	11.0
3/8-24 UNF	61.5	17.5	9.5

Packard Connector with 22mm Hex

8 - 30 Vdc Input : 1 - 5 Vdc Output

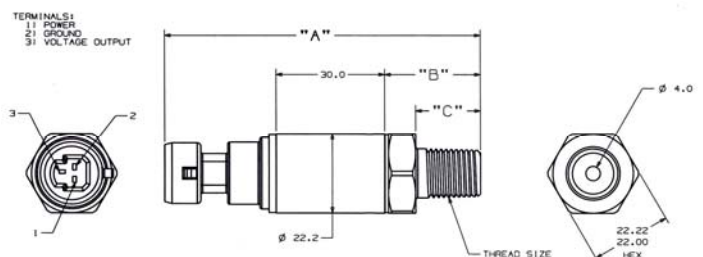

THREAD SIZE	LENGTH "A"	LENGTH "B"	LENGTH "C"
1/4-18 NPT	80.0	26.0	18.0
1/8-27NPT	75.0	21.0	13.0
7/16-20UNF	73.0	19.0	11.0
9/19-18 UNF	73.0	19.0	11.0
3/8-24 UNF	71.5	17.5	9.5

Packard Connector with 22mm Hex

8 - 30 Vdc Input : 4 - 20 mA Output

Mating Packard Connector P/N 12065287 and Mating Packard Terminal P/N 12103881

SSI Technologies – Application Note PS-AN9

MediaSensor™ P51 Series LA

Low Pressure Absolute Pressure Sensors

Typical Performance Specifications (all values at 22°C unless noted otherwise)

Output Type	0.5 to 4.5 Volts	4 – 20 mA	1 – 5 Volts
Accuracy ¹ (75 PSI TO 200 PSI)	<± 0.50% FS	<± 0.50% FS	<± 0.50% FS
Thermal Error ⁶ (-40°C to 105°C)	<± 0.50% FS	<± 0.50% FS	<± 0.50% FS
Accuracy ¹ (15 PSI TO 50 PSI)	<± 1.00% FS	<± 1.00% FS	<± 1.00% FS
Thermal Error ⁶ (-40°C to 105°C)	<± 1.00% FS	<± 1.00% FS	<± 1.00% FS
Zero Pressure Offset ²	0.50 V	4.0 mA	1.0 V
Full Scale Output ³	4.5 V	20 mA	5.0 V
Operating Temperature	-40 to 105°C	-40 to 105°C	-40 to 105°C
Storage Temperature	-40 to 105°C	-40 to 105°C	-40 to 105°C
Proof Pressure	3 X FS	3 X FS	3 X FS
Burst Pressure Absolute Pressure Transducers	10 X FS or 15,000 PSI (whichever is less)	10 X FS or 15,000 PSI (whichever is less)	10 X FS or 15,000 PSI (whichever is less)
Reverse Voltage Protection (+/- 16V over 5 minutes)	N/A	Reverse	Reverse
Overvoltage Protection Option (+/- 16V over 5 minutes)	Available	N/A	N/A

Electrical Specifications

Output Type	0.5 to 4.5 Volts	4 – 20 mA	1 – 5 Volts
Supply Voltage	5 +/- 0.5	8 to 30 Volts	8 to 30 Volts
Supply Current	< 6 mA	Not Applicable	< 3 mA
Output Current	0.45mA Max (Sink or Source)	Not Applicable	0.45mA Max (Sink or Source)
Response Time	< 1 ms	< 1 ms	< 1ms

Reliability and Environmental Performance

	Test Conditions	Value	Units
Pressure/Temperature Cycles ⁴	0 to FS @ 8Hz; and -40°C to 105°C	>1.8x10 ⁶	Cycles
Thermal Shock	105°C to -40°C, 0.5 hr soaks at Temp. (2s Transfer)	300	Cycles
Vibration	100 to 2000 Hz, 20g Sinusoidal, 3 Axes	144	Hours
EMC Compatibility ⁵	10 Volts/meter per EN 61000-4-3		
Humidity	85°C and 90% to 95% R. H.	250	Hours
Weight	Model 51 with M12 x 1.5 6g 304L Stainless Port	≤85	Grams

¹Includes hysteresis, repeatability, & non-linearity (BFSL)

²Transducer output @ 0 PSIA, 0 PSIG, or 0 PSIS (consult factory for other options)

³Sealed Transducer output @ Pressure Range + 14.5 PSIA

⁴Pressure cycling performed at rated full scale pressure.

⁵Higher levels of EMC Compatibility are available upon request.

⁶ Additional over temperature

MediaSensor™ Series LA Absolute Pressure Sensor Ordering System

SSI TECHNOLOGIES, INC.

Controls Division

2643 W. Court Street

Janesville, WI 53548-5011

Phone: (608)758-1500 Fax: (608) 758-2491

www.ssistechnologies.com



SSI Technologies, Inc.

Copyright April 20, 2010

SSI Technologies Inc.

All Rights Reserved

Revision 2



SSI Technologies – Application Note PS-AN9

MediaSensor™ P51 Series LA

Low Pressure Absolute Pressure Sensors

The following explains SSI's low pressure sensor order number sequence.

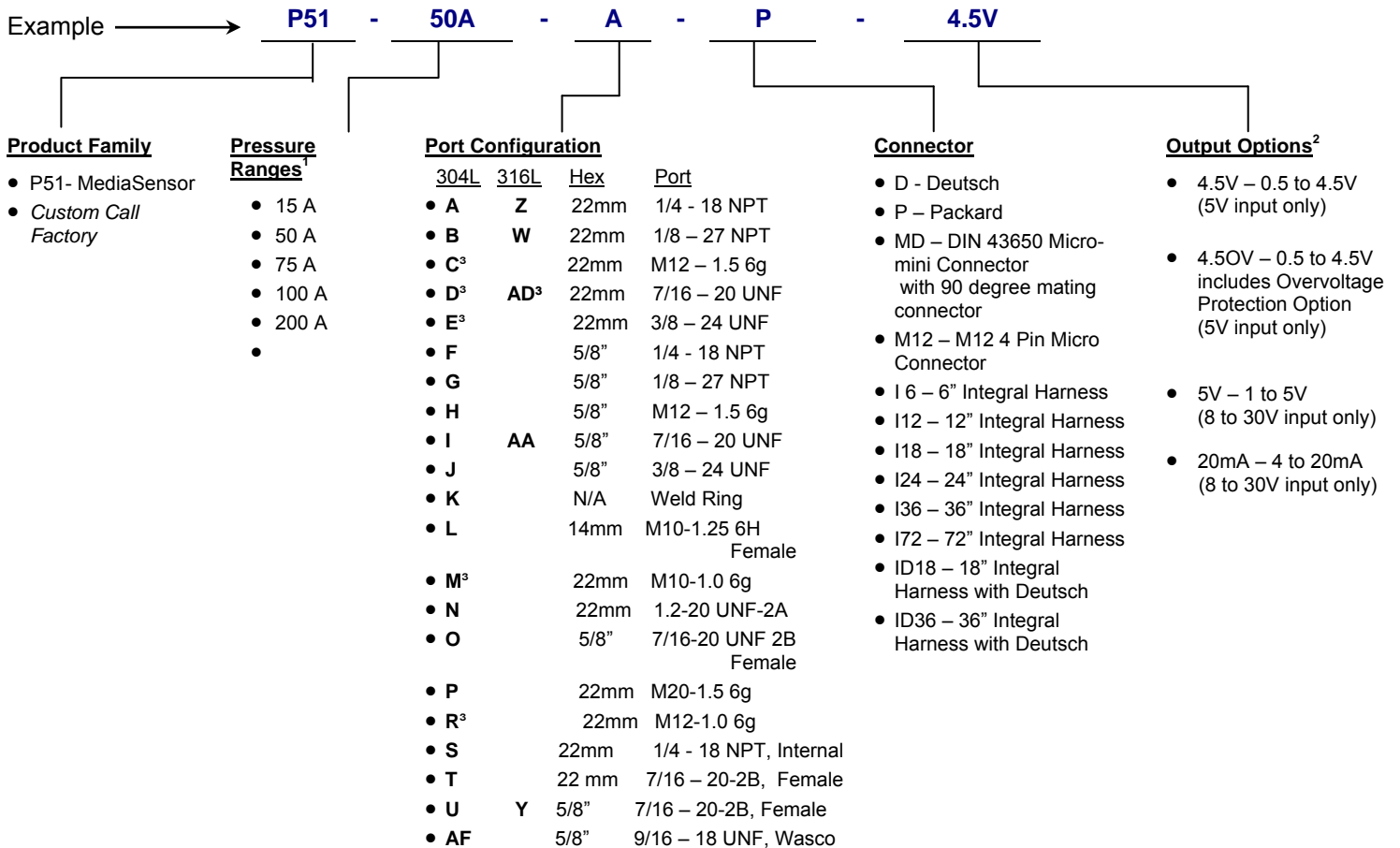

- Notes:**
- 1) A designates Absolute Pressure
 - 2) Calibration of the transducer is as follows:
 - a. Absolute Transducers are calibrated to have the 0.5 Vdc, 1 Vdc, or 4 mA respectively at 0 PSIA
 - 3) These ports are not available with pressure sensors with the 50 PSI or below pressure ranges.

To place an order or to view our other pressure sensors, please see our website <http://www.ssitechnologies.com> for a listing of our distribution partners and Regional Sales Managers

For custom orders or specifications not listed, call SSI toll-free at **1- 888- 477- 4320**

